

User manual

MyHand

Revision: 03 — Date: May 2021

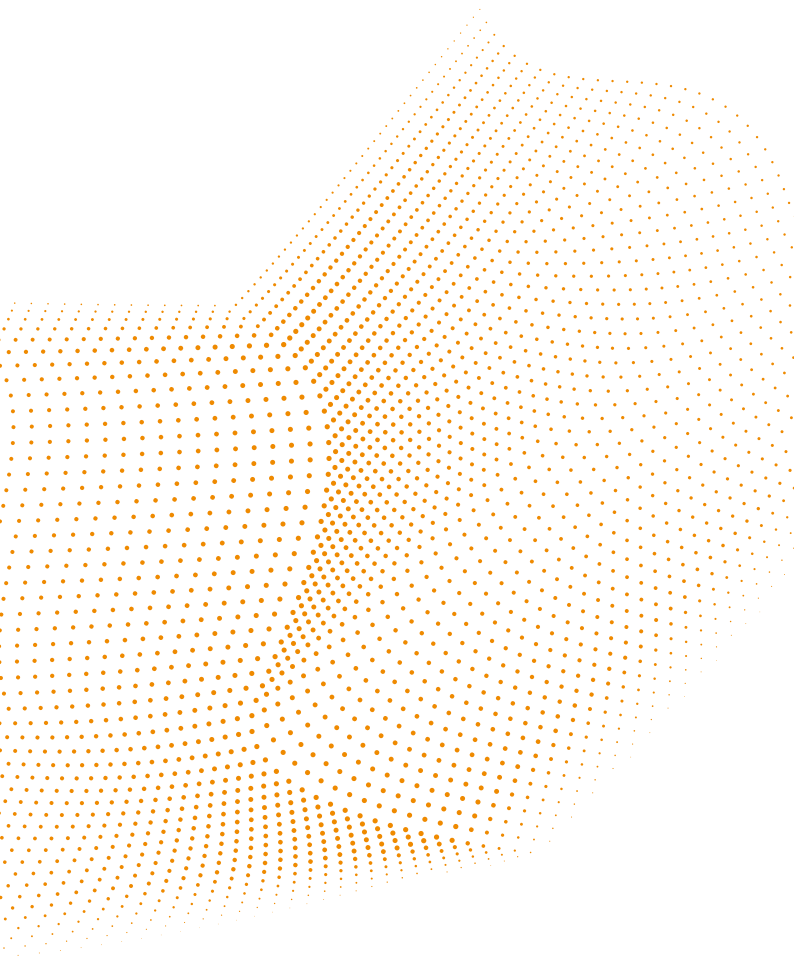

user id:		#45
product nr:		
date of manufacture:		

Table of Contents

1	Introduction	4
2	Use & Care	5
	2.1 On/Off	5
	2.2 Quick Disconnect	5
	2.3 Grips	6
	2.4 Emergency Release Switch	7
	2.5. Maintenance, Care and Cleaning	8
	2.6. Battery	8
3	Service & Warranty	9
	3.1. Service	9
	3.2. Warranty	9
4	Safety/Cautions	9
5	Disposal	10
6	FAQ	10
7	Technical information	12
8	Quality Assurance	12
9	Hy5 App	13
10	Incident reporting	13

1. INTRODUCTION

Thank you for choosing Hy5 as your prosthesis supplier. This manual along with the training and support of your clinical team will help you take full advantage of your MyHand. This manual contains important information for the correct use of MyHand. For instruction videos please visit our website www.hy5.no.

Read this document thoroughly before using your MyHand.

MyHand is a size 7 $\frac{3}{4}$ and requires a socket with a female electric quick disconnect, a 5A battery and one or two myo-sensors to work. MyHand is connected to the socket with the quick disconnect. A MySkin glove size 7 $\frac{3}{4}$ shall be used on the MyHand at all times.

MyHand is intended for any individual adult with a hand amputation or dysmelia, to regain independence in their daily social and work life, helping to perform everyday activities that able-bodied individuals take for granted. The size of the MyHand is equal to a male size 7 $\frac{3}{4}$. Despite the size, MyHand can be used by both genders independent of height, weight, and age.

Prior to use, please download the Hy5 app that is available in either iOS or Anroid formats.

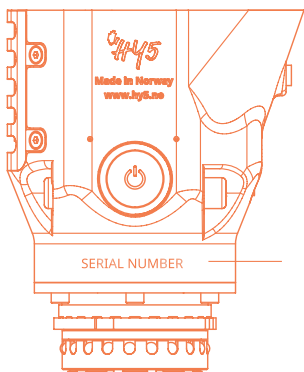

MyHand has a unique serial number on the wrist, to allow easy identification.

2. USE & CARE

MyHand is ready to be used when connected to your prosthetic socket. Secure connection is achieved by pushing MyHand on to the socket, by twisting your MyHand 45-degrees in either direction. Adjustments of the myo sensors may be needed to get full functionality of the MyHand. Your prosthesis provider will help you with this if needed. To get the most from the MyHand, make sure your socket and hand are comfortable and secure.

⚠ CAUTION! — Your socket must include a Hy5 recommended or supplied battery to function optimally. If you experience unintentional behaviour or MyHand does not work as expected, take off your MyHand and contact your clinician.

2.1 On/Off

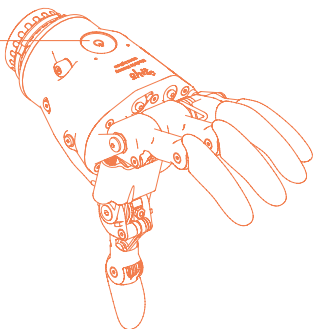

Pressing and holding down the button for approximately 2 seconds will switch the hand ON. A short movement of the fingers will occur, to give you a physical indication that the hand is turned ON. Pressing and holding down the button again for approximately 2 seconds will switch the hand OFF. Pressing the same button quickly three times in succession will turn ON the AutoGrasp function on your MyHand. Repeat to turn the function OFF.

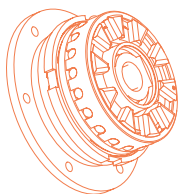

2.2 Electric Quick Disconnect

There is currently one wrist option for the MyHand; the standard Electric Quick Disconnect (EQD). The EQD allows the hand to be moved through a 360 degree rotating action.

2.3 Grips

MyHand has several adaptive grips. The fingers will fold around any given form or object. To make a fist, tripod grip or finger point grip, you have to actively help the hand to achieve the desired grip position.

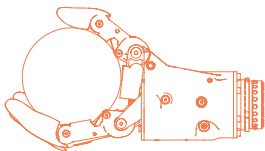

POWER

All five fingers close together to grip around larger objects such as a bottle, a ball or a piece of fruit.

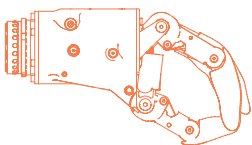

PINCH

Close the hand, and the fingers will form a pinch grip.

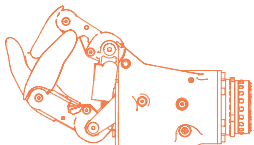

FIST

Hold back the thumb while closing all the other fingers, then release the thumb.

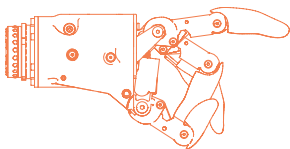

FINGER POINT

Hold back the index finger while closing all the other fingers.

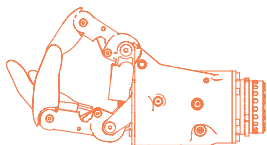

TRIPOD

Use a flat surface to manipulate the fingers into this grip. The tripod grip allows you to grip objects between the thumb and the index and middle fingers.

 **CAUTION!** — MyHand has a powerful grip and can damage items and/or the body, if you squeeze too hard.

2.4 Emergency Release Switch

An emergency release switch is situated on the back of the hand, just below the On/Off button. If for any reason you should need to quickly release the fingers from a grip, hold the emergency release with your thumb and index finger, and push the release switch to the side. The fingers will open instantly. Left hand users shall push the switch to the right, and Right hand users shall push the switch to the Left.

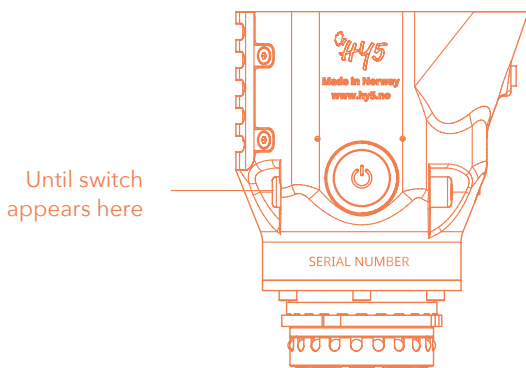
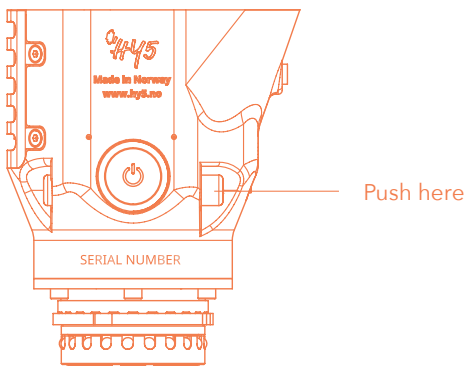

 **CAUTION!** — Push the release switch back to its initial place, to activate the MyHand for use again. It is very important that the switch is pushed all the way back, or the fingers will not move.

2.5 Maintenance, Care and Cleaning

Please inspect your prosthesis regularly. Do not adjust, dismantle or attempt to maintain, or modify your prosthesis. If the MyHand does not function as expected, please contact your prosthetic provider. The MyHand is like any other electrical device, do not immerse in water. When cleaning MyHand, use a damp cloth. For instructions on how to clean the glove, read the dedicated MySkin user manual.

If water enters the internal components of the hand, component failure can occur. Inspect the prosthesis regularly for glove damage. Try to avoid contact with sharp or pointed objects. When in need of a replacement glove please contact your prosthetic provider.

Regular maintenance schedule for MyHand shall be every 12 months.

2.6 Battery

 **CAUTION!** — Do not use MyHand if there is visible damage on the hand prosthesis. Do not use MyHand while sunbathing or in direct sunlight. The MyHand should not be left in an environment $>35^{\circ}\text{C}$. MyHand shall only be used according to the intended use.

The MyHand is powered by a rechargeable battery located in the socket.

 **CAUTION!** — Only a Hy5 recommended or supplied battery should be used with the MyHand. The battery shall be charged when the speed of the movements starts to slow down or the MyHand is difficult to open. Contact your prosthesis provider if the battery does not charge.

3. SERVICE & WARRANTY

3.1 Service

Any repair must be performed by Hy5 or a Hy5 certified orthopedic workshop. Upon return, the hand will be assessed and where deemed beyond repair replaced if the warranty is applicable.

3.2 Warranty Statement

The MyHand comes with a 2-year-standard warranty. The warranty covers any defects in materials or workmanship under normal use during the warranty period. The 2-year warranty period begins when the product is taken into use, which should be no later than 6 months from the date of product shipment from Hy5's production facility, Norway.

Taken into use is defined as date of shipment to practitioner/end user. When a claim is made under warranty, this claim must be supported by appropriate documentation, including proof of sale and shipment date.

The warranty will be void on all system components if any components have been subject to abuse, repair or maintenance by an uncertified person; deliberate damage; loads beyond those for which the product was designed; or by modification or neglect.

The warranty does not cover products that have not been subject to the recommended maintenance schedule. The regular maintenance schedule is required in order to maintain components subject to wear and tear, in addition to bleeding air from the hydraulic system.

4. SAFETY/CAUTIONS

MyHand accepts no responsibility for any damage or injury caused by improper use.

- Do not subject the MyHand to excessive loads
- Always use with a Hy5 MySkin glove.
- Do not use in water
- Do not use to operate heavy / industrial machinery
- Do not use machinery with moving parts that may cause personal injury or damage.
- Users must comply with local regulations on the operation of automobiles, aircraft, sailing vessels of any kind and any other

motorized vehicle or device

- Do not use MyHand for extreme activities that may cause injury
- Do not expose for excessive moisture, liquid, dust, vibration or shock
- Do not expose to high temperatures
- Do not expose to flames
- Do not use or expose to explosive atmospheres
- Do not disassemble componentry or modify in any way
- Maintenance, repairs and upgrades may only be performed by qualified Hy5 technicians and technical partners
- Do not use with a damaged glove
- Do not use while batteries are charging

5. DISPOSAL

When disposing of MyHand, please send it back to Hy5pro AS for safe disassembly and disposal.

6. FAQ

Q	A
Will I be able to move each digit individually?	While there are a number of possible grip patterns, you will not have individual control of each digit.
Q	A
How long will it take to learn to use the MyHand?	MyHand should work instantly, but a short learning period is to be expected.
Q	A
Can I use MyHand for sports?	Yes. MyHand can be used for most sports. Consult with your prostheses provider if you have questions regarding usage limitations.

Q My battery does not last all day, what can I do?

A Ensure your socket is fitted with a Hy5 recommended battery and it is fully charged before use.

Q I had good control when I first got the hand, but now it seems like I drop items more easily. Why is that?

A The signals you are giving may have become stronger over time since you have been using the hand more. Now even a small muscle contraction may make the hand move. Your prosthetist may help you to adjust the sensitivity of the myo-sensors in your sleeve.

Q What if the device gets wet in the rain?

A You should dry it as soon as you can and always ensure your glove is free from holes. You do not want water to get under the glove. Treat the hand like you would treat a cell phone.

Q How should I clean it? And how often?

A You should clean your MyHand on a regular basis. When cleaning MyHand, use a damp cloth.

Q What is the best way to tie my shoes?

A Many MyHand users prefer to use the pinch grip.

Q How can I put a coat on if my device is already on?

A Using the pinch grip will bring the thumb and fingers together, and make the hand as slim as possible.

7. TECHNICAL INFORMATION

Principal dimensions

Maximum opening - thumb opposed to index finger	120 mm
Thumb swing through angle (opposed to non-opposed)	70°

Performance specification

Maximum power grip	120 N
Maximum tripod grip	60 N
Minimum time to open/close: power grip	1.0 Sec.
Minimum time to open/close: pinch grip	1.0 Sec.
Maximum static load: hook grip	40 kg
Maximum load individual finger - hook grip	20 kg
Fingertip extension load	8 kg
Weight	575 g
Size	7 ¾

Battery

Maximum current	5A
Voltage	7.2V
Battery capacity	rechargeable lithium polymer, 2200mah

Environmental conditions

Storage and transport in original packagin	+5°C to +35°C / +41F to +95F
Storage and transport without packaging	+5°C to +35°C / +41F to +95F
Operation	+5°C to +35°C / +41F to +95F

8. QUALITY ASSURANCE

Hy5 is registered with the Directory of health in Norway.
Hy5 is marked with a CE mark indicating that it complies with the requirements of the Medical Devices Directive 93/42/EC.

9. HY5 APP

The Hy5 App is created together with upper extremity CPO's and patients to make it easy to customize MyHand to the patients desired settings and to train the myoelectrical muscle signals. The App can be used by both patient and CPO.

The App communicates with MyHand through a Bluetooth signal in the prosthesis. You need to pair MyHand to a mobile or tablet, when you have downloaded the App. The Bluetooth in MyHand will be activated by holding the ON/OFF button in for approximately 5-6 seconds.

In the Dashboard module of the App, you can see the battery status, and the service status of MyHand.

In the Diagnostics module, you can check the status of MyHand by running a diagnostic and send the report to the Hy5 team. When you do this, Hy5 will analyze the results and get back to you. You can also run a log report. This function is mainly so we can log the EMG signals and suggest an optimal setting for the patient.

The Training module contains a function where you can see how the myo-signal response is right now, as well as several games which can be used for muscle training to get a better performance with MyHand.

In the Settings module, you can adjust the settings of MyHand and the myo-sensors to your preferences.

On our website you can find a step-by-step tutorial on how to use the App!

10. INCIDENT REPORTING

Complaints or accidents involving Hy5 products should be reported via the 'contact' page on the Hy5 website www.hy5.no



11. USER INFORMATION

Provision of the following basic information will enable easy identification for future service inquiries.

User name:

Fitting date:

Date of first use:

Hand serial number:

Orthopedic workshop & contact information:



FDA

FDA Registration Number: 3014936213



CE mark

Declaration of conformity according to the applicable European directives



Legal manufacturer

Hy5Pro AS, Raufoss Industripark, Bygning 100, 2830 Raufoss, NORWAY

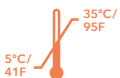

Storage Temperature Limit:

5°C/41F to +35°C/95F

